

Data sheet | Item number: 750-333

Fieldbus Coupler PROFIBUS DP; 2nd Generation; 12 MBd

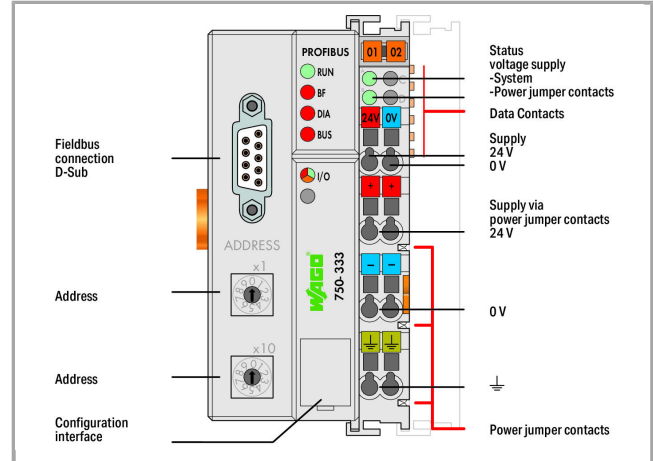

750-333



RoHS Compliant

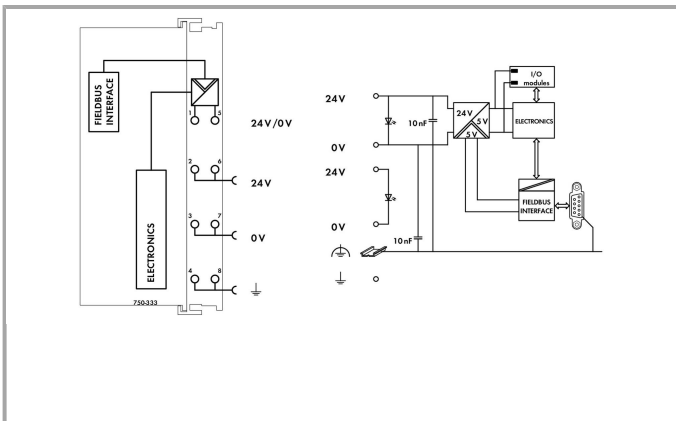

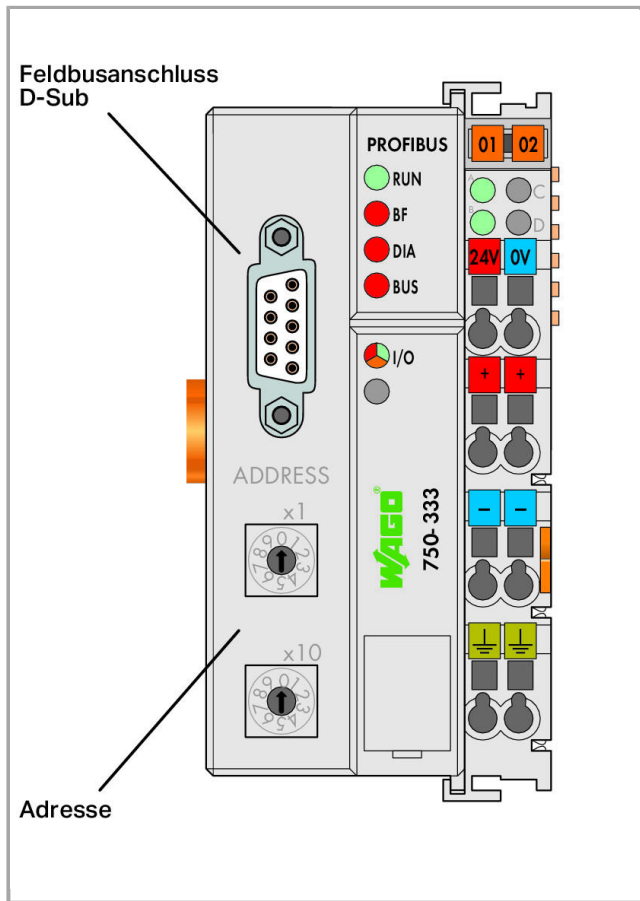

Item description

This buscoupler interfaces the I/O modules of the WAGO-I/O-SYSTEM to PROFIBUS DP.

When initializing, the buscoupler determines the module structure of the node, to create the process image in PROFIBUS. In order to optimize addresses, the I/O modules with a bit width smaller than 8 are grouped in one byte.

It is furthermore possible to deactivate I/O modules and to modify the image of the node according to the connected signals without having to modify the existing application.

The diagnosis concept is based on diagnostics according to the EN 50170 standard. Therefore the programming of modules is not necessary to interpret the diagnostic information from each manufacturer.

Note:

Notice: GSD files required

Data

Technical Data

Communication	PROFIBUS
Number of fieldbus nodes on the master max.	96



Max. no. of I/O points	6000
Baud rate	9.6 kBd ... 12 MBd
Fieldbus segment length max.	1200 m
Transmission medium	Cu cable acc. to EN 50170
Transmission time	typ. 1 ms (10 couplers; 32 digital I/Os per coupler at 12 Mbaud) max. 3.3 ms
Number of modules per node max.	63
Input and output process image (Fieldbus) max.	244 Byte/244 Byte
System supply voltage	DC 24 V(-25 ... +30 %); via wiring level (CAGE CLAMP® connection)
Current consumption, system supply (5 V)	200 mA
Total current for system supply	1800 mA
System and sensor supply voltage)
Field supply voltage	DC 24 V (-25 ... +30 %); via power jumper contacts
Input current typ. at rated load (24 V)	500 mA
Efficiency of the power supply (typ.) at nominal load (24 V)	87 %
Isolation	500 V system/supply
Number of outgoing power jumper contacts	3
Current carrying capacity of the power jumper contacts	10 A
Standard	EN 50170

Connection data

Connection technology: communication/fieldbus	PROFIBUS: 1 x D-Sub 9 socket
Connection technology: field supply	6 x CAGE CLAMP®
Connection technology: system supply	2 x CAGE CLAMP®
Connection technology: Device configuration	1 x 4-pole male connector
Connection type (1)	System/field supply
Solid conductor	0.08 ... 2.5 mm ² / 28 ... 14 AWG
Fine-stranded conductor	0.08 ... 2.5 mm ² / 28 ... 14 AWG
Strip length	8 ... 9 mm / 0.31 ... 0.35 inch

Geometrical Data

Width	50.5 mm / 1.988 inch
Height	71.1 mm / 2.799 inch
Height from upper-edge of DIN-35 rail	63.9 mm / 2.516 inch
Depth	100 mm / 3.937 inch

Mechanical data

Type of mounting	DIN-35 rail
------------------	-------------

Material Data

Color	light gray
Housing material	Polycarbonate, polyamide 6.6
Fire load	2.779 MJ
Weight	183.143 g
Conformity marking	1

Environmental Requirements

Surrounding air (operating) temperature	0 ... 55 °C
Surrounding air (storage) temperature	-40 ... 85 °C
Protection class	IP20
Degree of pollution (5)	2 per IEC 61131-2
Operating altitude	0 ... 2000 m
Mounting position	horizontal (standing/lying) or vertical
Relative air humidity (no condensation)	95 %
Vibration resistance	4g per IEC 60068-2-6
Shock resistance	15g per IEC 60068-2-27
EMC immunity to interference	acc. to EN 61000-6-2, marine applications
EMC emission of interference	acc. to EN 61000-6-4, marine applications
Exposure to pollutants	Per IEC 60068-2-42 and IEC 60068-2-43
Permissible H ₂ S contaminant concentration at a relative humidity 75 %	10 ppm
Permissible SO ₂ contaminant concentration at a relative humidity 75 %	25 ppm

Commercial data

Product Group	15 (Remote I/O)
Country of origin	DE
GTIN	4045454526856
Customs Tariff No.	85176200000

Approvals / Certificates

Ex-Approvals

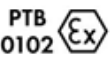
Logo	Approval	Additional Approval Text	Certificate name
	ATEX TUEV Nord Cert GmbH	EN 60079-0	TÜV 07 ATEX 554086 X en.
	TUEV Nord	IEC 60079-0	IECEX

TUEV Nord Cert GmbH



TUN
09.0001 X

UL
Underwriters Laboratories Inc. (HAZARDOUS
LOCATIONS)



ANSI/ISA 12.12.01

E198726
Sec.1



Country specific Approvals

Logo	Approval	Additional Approval Text	Certificate name
	KC National Radio Research Agency	Article 58-2, Clause 3	MSIP- REM-W43- FBC750
	KC National Radio Research Agency	Article 58-2, Clause 3	MSIP- REM-W43- FBC750

Ship Approvals

Logo	Approval	Additional Approval Text	Certificate name
	ABS American Bureau of Shipping	-	19- HG1821926
	ABS American Bureau of Shipping	Rules for class. of Steel Ships	16- HG1554285- PDA
	BV Bureau Veritas S.A.	-	13453/DO BV
	DNV GL Det Norske Veritas, Germanischer Lloyd	-	TAA0000194
	KR Korean Register of Shipping	-	HMB05880- AC001
	LR Lloyds Register	-	02/20026 (E5)









	NK Nippon Kaiji Kyokai	-	TA17255M
	PRS Polski Rejestr Statków	-	TE/2236 /880590/19
	RINA RINA Germany GmbH	-	ELE134212XG

















UL-Approvals















Logo	Approval	Additional Approval Text	Certificate name
	UL UL International Netherlands B.V. (ORDINARY LOCATIONS)	UL 508	E175199 Sec.1

Compatible products

Carrier rail

	Item no.: 210-112 Steel carrier rail; 35 x 7.5 mm; 1 mm thick; 2 m long; slotted; according to EN 60715; "Hole width 25 mm	210-112
	Item no.: 210-113 Steel carrier rail; 35 x 7.5 mm; 1 mm thick; 2 m long; unslotted; according to EN 60715	210-113
	Item no.: 210-114 Steel carrier rail; 35 x 15 mm; 1.5 mm thick; 2 m long; unslotted; similar to EN 60715	210-114
	Item no.: 210-115 Steel carrier rail; 35 x 7.5 mm; 1 mm thick; 2 m long; slotted; according to EN 60715; "Hole width 18 mm	210-115
	Item no.: 210-118 Steel carrier rail; 35 x 15 mm; 2.3 mm thick; 2 m long; unslotted; according to EN 60715	210-118
	Item no.: 210-196 Aluminum carrier rail; 35 x 8.2 mm; 1.6 mm thick; 2 m long; unslotted; similar to EN 60715	210-196

	Item no.: 210-197 Steel carrier rail; 35 x 15 mm; 1.5 mm thick; 2 m long; slotted; similar to EN 60715	210-197
	Item no.: 210-198 Copper carrier rail; 35 x 15 mm; 2.3 mm thick; 2 m long; unslotted; according to EN 60715	210-198
	Item no.: 210-504 Steel carrier rail; 35 x 7.5 mm; 1 mm thick; 2 m long; slotted; galvanized; according to EN 60715	210-504
	Item no.: 210-505 Steel carrier rail; 35 x 7.5 mm; 1 mm thick; 2 m long; unslotted; galvanized; according to EN 60715	210-505
	Item no.: 210-506 Steel carrier rail; 35 x 15 mm; 1.5 mm thick; 2 m long; unslotted; galvanized; similar to EN 60715	210-506
	Item no.: 210-508 Steel carrier rail; 35 x 15 mm; 1.5 mm thick; 2 m long; slotted; galvanized; similar to EN 60715	210-508
Marking accessories		
	Item no.: 2009-145 Mini-WSB Inline; for Smart Printer; on reel; stretchable 5 - 5.2 mm; plain; snap-on type	2009-145
	Item no.: 2009-145/000-002 Mini-WSB Inline; for Smart Printer; on reel; stretchable 5 - 5.2 mm; plain; snap-on type	2009-145 /000-002
	Item no.: 2009-145/000-005 Mini-WSB Inline; for Smart Printer; on reel; stretchable 5 - 5.2 mm; plain; snap-on type	2009-145 /000-005
	Item no.: 2009-145/000-006 Mini-WSB Inline; for Smart Printer; on reel; stretchable 5 - 5.2 mm; plain; snap-on type	2009-145 /000-006
	Item no.: 2009-145/000-007 Mini-WSB Inline; for Smart Printer; on reel; stretchable 5 - 5.2 mm; plain; snap-on type	2009-145 /000-007
	Item no.: 2009-145/000-012 Mini-WSB Inline; for Smart Printer; on reel; stretchable 5 - 5.2 mm; plain; snap-on type	2009-145 /000-012
	Item no.: 2009-145/000-023 Mini-WSB Inline; for smartPRINTER; on reel; stretchable 5 - 5.2 mm; plain; snap-on type	2009-145 /000-023
	Item no.: 2009-145/000-024 Mini-WSB Inline; for Smart Printer; on reel; stretchable 5 - 5.2 mm; plain; snap-on type	2009-145 /000-024
	Item no.: 248-501 Miniature WSB Quick marking system; plain; Marker width 5 mm; 10 strips with 10 markers per card	248-501
	Item no.: 248-501/000-002 Mini-WSB marking card; as card; not stretchable; plain; snap-on type	248-501 /000-002

	Item no.: 248-501/000-005 Mini-WSB marking card; as card; not stretchable; plain; snap-on type	248-501 /000-005
	Item no.: 248-501/000-006 Mini-WSB marking card; as card; not stretchable; plain; snap-on type	248-501 /000-006
	Item no.: 248-501/000-007 Mini-WSB marking card; as card; not stretchable; plain; snap-on type	248-501 /000-007
	Item no.: 248-501/000-012 Mini-WSB marking card; as card; not stretchable; plain; snap-on type	248-501 /000-012
	Item no.: 248-501/000-017 Mini-WSB marking card; as card; not stretchable; plain; snap-on type	248-501 /000-017
	Item no.: 248-501/000-023 Mini-WSB marking card; as card; not stretchable; plain; snap-on type	248-501 /000-023
	Item no.: 248-501/000-024 Mini-WSB marking card; as card; not stretchable; plain; snap-on type	248-501 /000-024
	Item no.: 750-100 Marker card; as a DIN A4 sheet; plain	750-100
	Item no.: 750-103 Group marker carrier	750-103
	Item no.: 750-106 Group marker carrier	750-106
system box		
	Item no.: 850-804 IP65 enclosure; Stainless steel; WxHxD (400x123x200 mm); 4 x M20, 16 x M16, 28 x M12 cable grip	850-804
	Item no.: 850-804/000-001 IP65 enclosure; Stainless steel; WxHxD (400x123x200 mm); 2 x M20, 13 x M16, 32 x M12 cable grip	850-804 /000-001
	Item no.: 850-805 IP65 enclosure; Stainless steel; WxHxD (600x123x200 mm); 4 x M20, 19 x M16, 67 x M12 cable grip	850-805
	Item no.: 850-814/002-000 IP65 enclosure; Sheet steel (RAL 7035); WxHxD (200x120x200 mm); without flange plate	850-814 /002-000
	Item no.: 850-815/002-000 IP65 enclosure; Sheet steel (RAL 7035); WxHxD (300x120x200 mm); without flange plate	850-815 /002-000
	Item no.: 850-816/002-000 IP65 enclosure; Sheet steel (RAL 7035); WxHxD (400x120x200 mm); without flange plate	850-816 /002-000

**Item no.: 850-817/002-000**

IP65 enclosure; Sheet steel (RAL 7035); WxHxD (600x120x200 mm); without flange plate

/002-000

850-817

**Item no.: 850-825**

IP65 enclosure; Aluminium (RAL 7032); WxHxD (160x100x160 mm); 9 x M12, 4 x M20

850-825

**Item no.: 850-826**

IP65 enclosure; Aluminium (RAL 7032); WxHxD (240x100x160 mm); 4 x M20, 4 x M16, 14 x M12 cable grip

850-826

**Item no.: 850-826/002-000**

IP65 enclosure; Aluminium (RAL 7035); WxHxD (240x100x160 mm); 4 x M20, 4 x M16, 14 x M12 cable grip

/002-000

850-826

**Item no.: 850-827**

IP65 enclosure; Aluminium (RAL 7032); WxHxD (320x100x160 mm); 4 x M20, 8 x M16, 17 x M12 cable grip

850-827

**Item no.: 850-827/002-000**

IP65 enclosure; Aluminium (RAL 7035); WxHxD (320x100x160 mm); 4 x M20, 8 x M16, 17 x M12 cable grip

/002-000

850-827

**Item no.: 850-828**

IP65 enclosure; Aluminium (RAL 7032); WxHxD (480x100x160 mm); 4 x M20, 10 x M16, 35 x M12 cable grip

850-828

**Item no.: 850-828/002-000**

IP65 enclosure; Aluminium (RAL 7035); WxHxD (480x100x160 mm); 4 x M20, 10 x M16, 35 x M12 cable grip

/002-000

850-828

**Item no.: 850-834**

IP65 enclosure; Polyester (RAL 7032); WxHxD (164x100x164 mm); 9 x M12, 4 x M20

850-834

**Item no.: 850-835**

IP65 enclosure; Polyester (RAL 7032); WxHxD (244x100x164 mm); 4 x M20, 4 x M16, 14 x M12 cable grip

850-835

**Item no.: 850-836**

IP65 enclosure; Polyester (RAL 7032); WxHxD (324x100x164 mm); 4 x M20, 8 x M16, 17 x M12 cable grip

850-836

General accessories**Item no.: 750-921**

Bluetooth® Adapter

750-921

**Item no.: 750-923**

Configuration cable; USB connector; Length: 2.5 m

750-923

**Item no.: 750-923/000-001**

Configuration cable; USB connector; Length: 5 m







/000-001

750-923

shield connection**Item no.: 790-108**

Shield clamping saddle; 11 mm wide; diameter of compatible conductor

790-108

	Item no.: 790-116 Shield clamping saddle; 19 mm wide; diameter of compatible conductor; 7 ... 16 mm	790-116
	Item no.: 790-124 Shield clamping saddle; 27 mm wide; diameter of compatible conductor; 6 ... 24 mm	790-124
	Item no.: 790-140 Shield clamping saddle; diameter of compatible conductor	790-140
	Item no.: 790-208 Shield clamping saddle; 12.4 mm wide; 3 ... 8 mm	790-208
	Item no.: 790-216 Shield clamping saddle; 21.8 mm wide; 6 ... 16 mm	790-216
	Item no.: 790-220 Shield clamping saddle; 30 mm wide; 6 ... 20 mm	790-220
wiring and connectors		
	Item no.: 750-960 Fieldbus Connector PROFIBUS; with D-sub male connector; 9-pole	750-960

Downloads

Documentation

Manual			
PROFIBUS DP/ V1 Fieldbus Coupler EN 50170, 12 MBaud, digital and analog signals	V 1.2.0	pdf 7.6 MB	Download
Bid Text			
750-333 IO, Koppler	Apr 4, 2012	doc 29.2 kB	Download
Additional Information			
Disposal; Electrical and electronic equipment, Packaging	V 1.0.0	pdf 265.8 kB	Download
System Description			
Design Notes Basic conditions and recommendations for higher operational safety	V 2.0.0	pdf 1.5 MB	Download
750/753 Series I/O-System – General Product Information		pdf 1.7 MB	Download
Use in Hazardous Environments Term definition, marking and installation regulations	V 1.0.0	pdf 1.0 MB	Download
Overview on WAGO-I/O-SYSTEM 750 approvals		pdf 780.2 kB	Download



Application Notes

Application Note CoDeSys 2.3

HART-Tool-Routing über PROFIBUS mit 750-833 und 750-333 (a116140)	1.0.0	pdf	Download
Der Anwendungshinweis beschreibt die Einrichtung von Asset-Management-Systemen, welche das einfache, effiziente und schnelle Konfigurieren von HART-Feldgeräten ermöglichen. Am Beispiel des Cerabar PMC51 (Endress+Hauser) erfolgt die Anbindung des HART-Sensors an den WAGO-PROFIBUS-Controller (750-833) bzw. WAGO-PROFIBUS-Koppler (750-333). Der zyklische PROFIBUS-Master (750-8208) koordiniert den Profibus-Feldbus. Über den TH LINK PROFIBUS (azyklischer Profibus Master) können die Asset-Management-Anwendungen (WAGOframe, PACTware und FieldCare) azyklisch über das HART-Modul (750-482 bzw. 750-484) auf die HART-Feldgeräte zugreifen.	Mar 22, 2019	5.3 MB	

Application note SIEMENS

PROFIBUS DP & PROFINET IO Diagnose für Siemens CPU 300 & 400 (a100210)	V2.0.0	zip	Download
PROFIBUS DP & PROFINET IO Diagnosebausteine für eine Siemens CPU 300/400. Ebenfalls ist ein Baustein zum De-/Aktivieren einzelner Devices am Bus enthalten.	Oct 7, 2015	4.0 MB	
PROFIBUS DP & PROFINET IO Diagnose für Siemens CPU 1200 & 1500 (a100211)	V2.1.0	zip	Download
PROFIBUS DP & PROFINET IO Diagnosebausteine für eine Siemens CPU 1200/1500. Ebenfalls ist ein Baustein zum De-/Aktivieren einzelner Devices am Bus enthalten.	Nov 25, 2016	11.9 MB	
Using iPar-Server option with WAGO PROFIsafe modules (a114802)	V 10.3	zip	Download
Usage WAGO PROFIsafe modules V2 iPar in combination with Siemens safety plc and technology iPar-Server and TCI. Supported tools Step 7 V5.5, Tia V13 SP1 UP9, TIA V13 SP2, TIA V14, TIA V14 SP1 and TIA V15. Supported PLC 3xxF, 4xxF, 15xxF and 12xx FC.	Mar 19, 2019	102.9 MB	

Runtime Software

Firmware

Firmware: 750-333 Fieldbus Coupler PROFIBUS DP; 2nd Generation; 12 MBd	20	zip	Download
	Mar 28, 2019	499.2 kB	

CAD/CAE - Smart Data

CAD data

3D Download 750-333		URL	Download
---------------------	--	-----	----------

Device Files

Device Description File



EDD file for SIMATIC PDM for 750-333, 750-833, 750-482, 750-484	1.0 Nov 22, 2010	zip 185.2 kB	Download
750-910; GSD files for PROFIBUS / 750, 752, 755, 758 and 767 Series	6.3 Jun 15, 2017	zip 4.7 MB	Download
Device Driver			
WAGO USB Service Cable Driver / 750 and 857 Series 759-923	6.5.3.0 Sep 10, 2014	zip 4.8 MB	Download

Product family

750/753 Series I/O-System

[Learn more about the product family.](#)

[Show all products from the family](#)

Subject to changes.